

Connection length and wire requirement

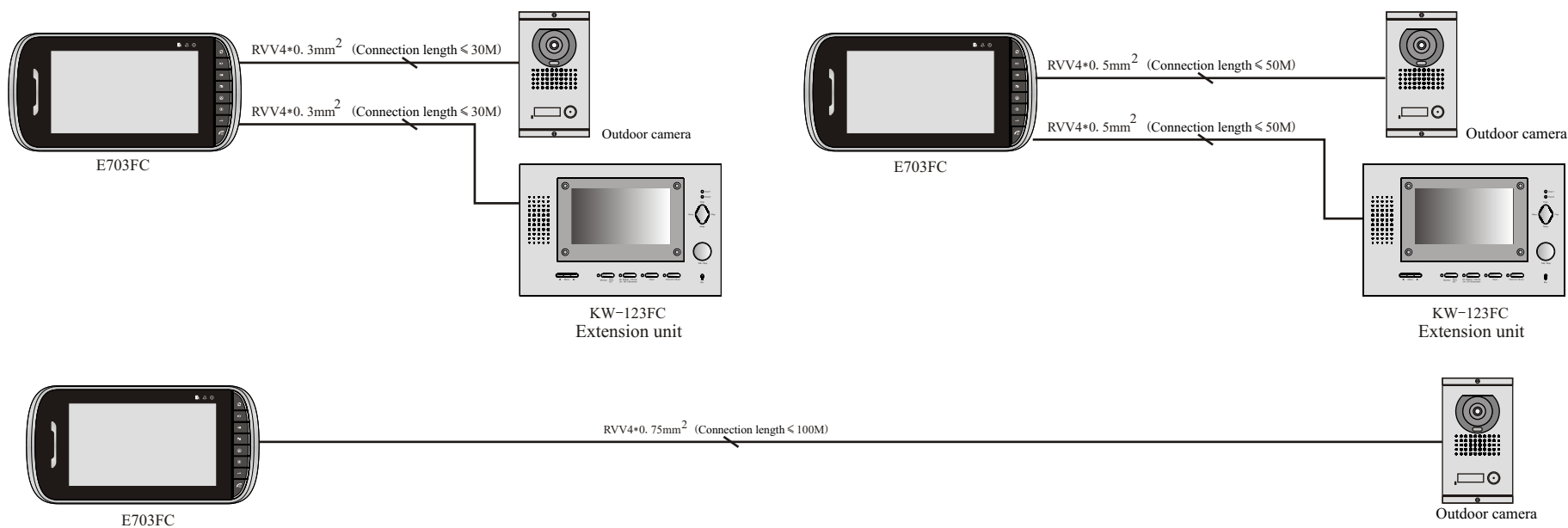

The wire's specific resistance should be ≤ 0.06 ohm/m.
In order to make sure the best picture quality and operation, please choose the wire according to the above indication.

Connection diagram between indoor monitor and outdoor camera (1pc indoor monitor + 1pc outdoor camera + 2pcs CCTV cameras)

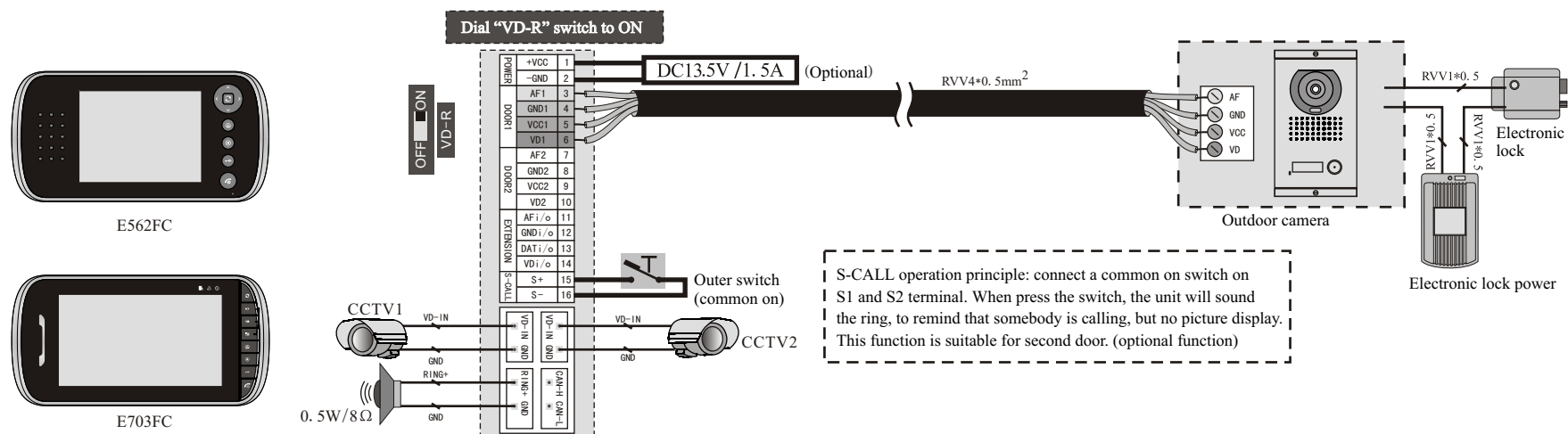

Connection diagram between indoor monitor and outdoor camera (1pc indoor monitor + 2pc outdoor camera + 2pcs CCTV cameras)

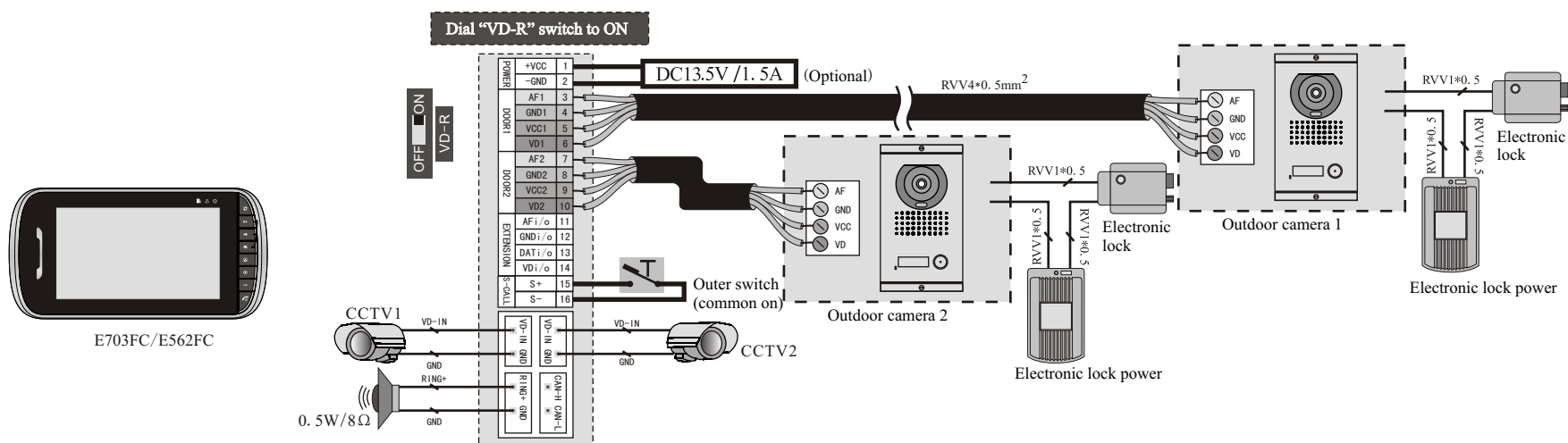

Connection diagram between indoor monitor and outdoor camera (4pcs indoor monitors + 2pc outdoor camera + 8pcs CCTV cameras)

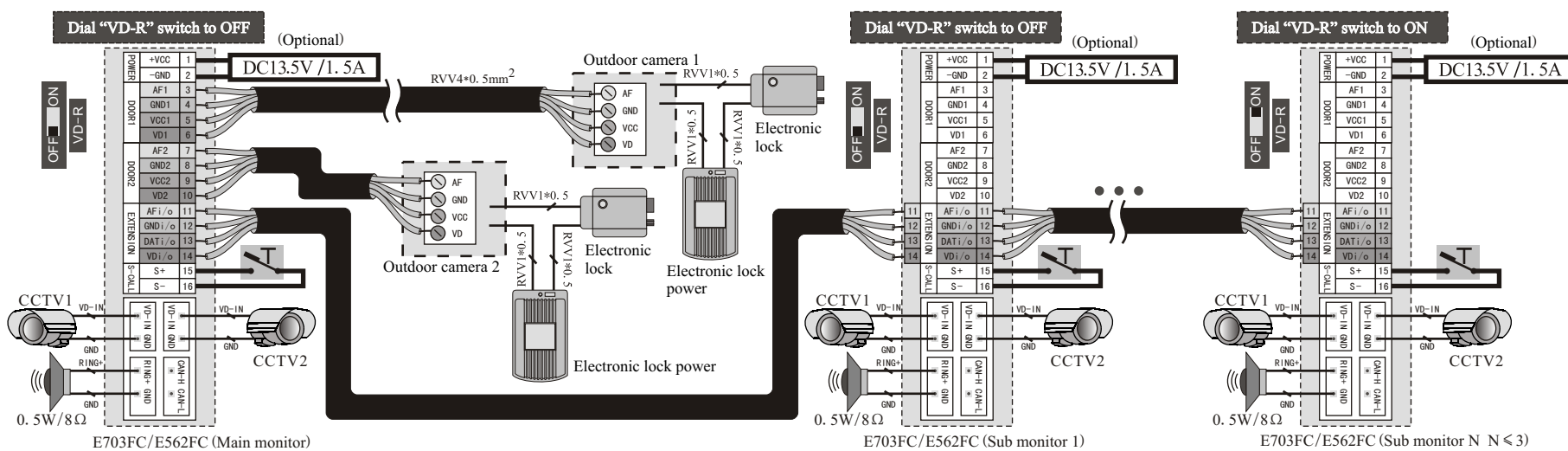

Remark: The last monitor's "VD-R" switch should be dialed to "ON", others keep "OFF".

Specifications and accessories

Specifications:

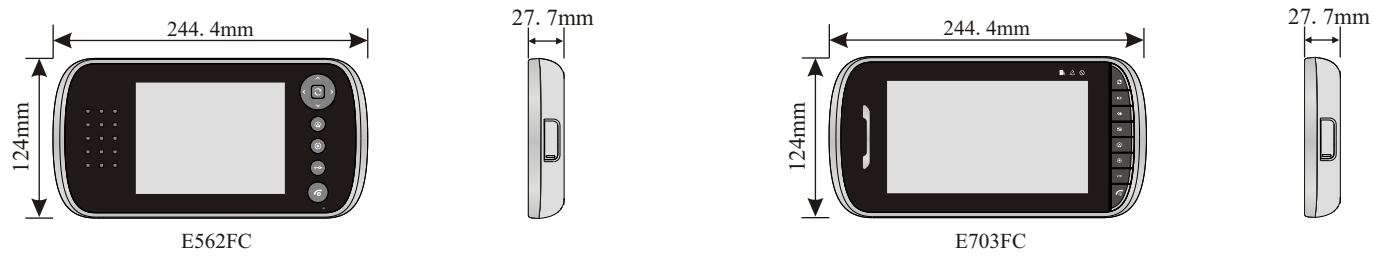

Accessories:

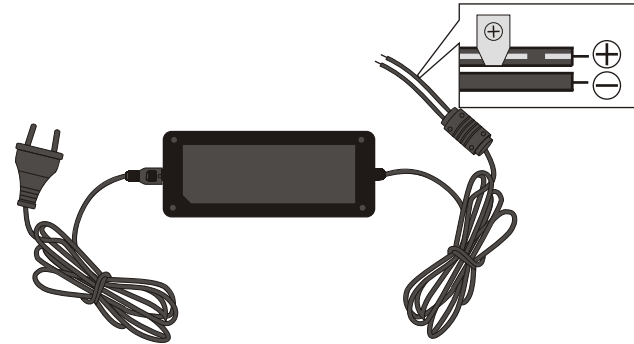
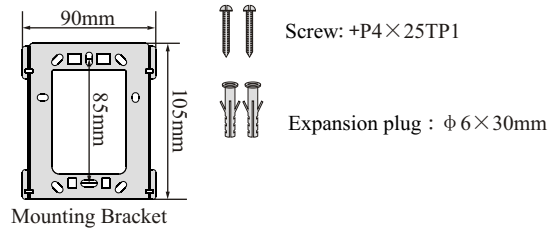

Input: AC110~240V, 50Hz/60Hz
Output: DC13.5V/1.5A
Power adaptor (optional)

Installation instruction

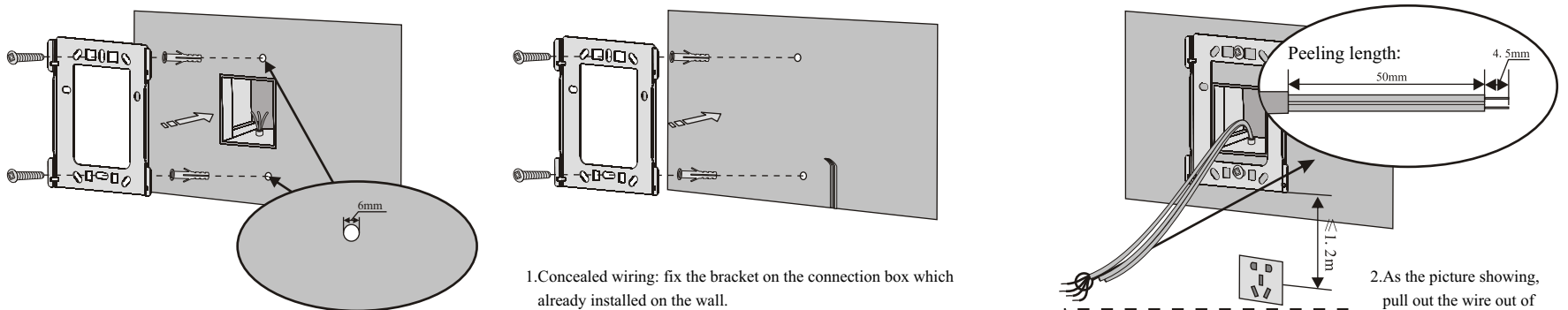

1. Concealed wiring: fix the bracket on the connection box which already installed on the wall.
Open wiring: drill 2 holes which distance should be 8.4cm, insert 2 expansion plug, then fix the bracket with screws.

Please install this unit near the power socket (the distance should be less than 1.2m).

2. As the picture showing, pull out the wire out of bracket, then peel the wire cover, see the peeling length on the picture..

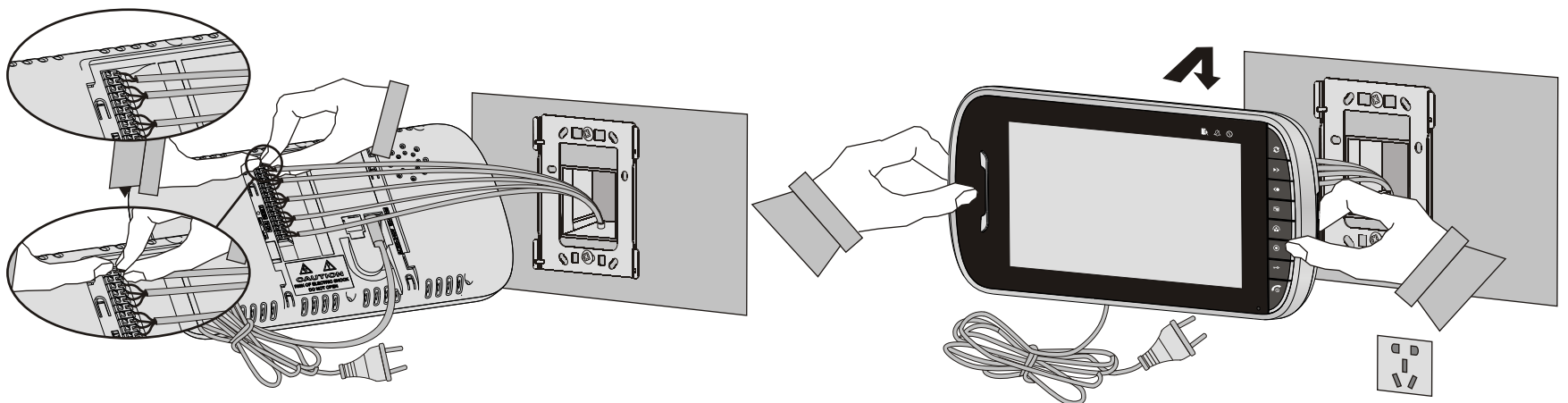

3. Connect the wire to each connection terminal, then check if the wire is fixed enough. (see the wiring sequence on the picture)

4. After connection, pack up the wire, hang up the unit to the bracket. (after hang up, power on the unit to test if the unit can work.)

Installation attention

1. When you choose the place to install the unit, please pay attention to:

Keep sufficient space for ventilation and easy communication.
Keep sufficient space to adjust while installing.
Not put hot resource under the unit.
The socket outlet shall be installed near the equipment and shall be easily accessible.

2. Do not expose the unit to sunshine or rain:

Even if you do not use it, don't expose it to sunshine or rain.

3. Do not expose to intense light:

Spotlight may cause stain or striation in the screen.

4. Do not disassemble the unit by yourself:

Improper disassembly may damage the unit or cause electric shock.

5. Do not splash water on the unit:

Install the unit in dry place. In case that the unit gets wet, turn off the unit and contact your dealer.

6. Check the ambient temperature and humidity:

Avoid using the unit where the temperature is hotter or colder than specified, otherwise the internal parts may get affected. Special care is required to use the unit at high temperature and humidity.

7. In case of trouble:

If any trouble occurs while you are using the unit, turn off the power and contact your dealer to avoid worse problem or unpredictable accident.

8. About operation:

Keep the unit away from magnetic equipments such as microwave oven or big speaker. If the unit will not be used for a long time, please switch it off.

9. About clean:

Use soft cloth to clean the unit. Do not use any impregnant, such as alcohol, benzene. If you have any problem, please contact your dealer.